



flosense[®]
FLEXIBLE FLOW MONITORING



Flosense; the new affordable, flexible flow monitoring system designed for accurate measuring and monitoring of flow, temperature and pressure variations in cooling circuits

Flosense is designed to be installed in various locations within the cooling circuit including the main water supply, the mould heater, critical cooling channels or distribution manifolds.

Quick to install and easy to set-up, Flosense is a critical component in any injection moulding configuration and should form part of any setup where cost control and quality are key considerations.

Using these values, Flosense provides an indication of the stability of the process and checks the efficiency, identifying wasted energy and variations in pressure which could indicate leaks or blocked waterways.

Flosense is designed to be installed in various locations within the cooling circuit including the main water supply, the mould heater, critical cooling channels or distribution manifolds.





Pressure loss is caused by hoses, fittings and valves and will affect the productivity.

Difference between inlet pressure and return pressure is measured as Delta P.

Variation in Delta P could indicate pump failure, blocked waterway, leaks etc.

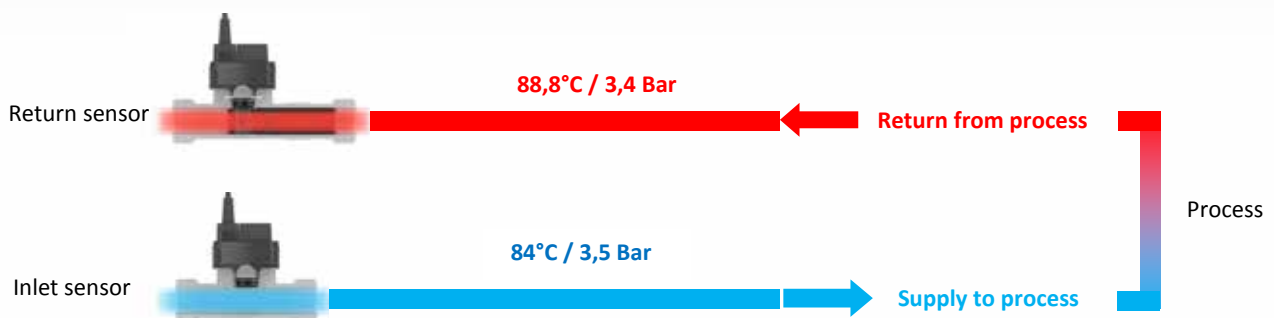

As the cooling water passes through the mould it transfers heat from the steel into the cooling water. The more turbulent the flow the more efficient this process of cooling.

Difference between inlet temperature and return temperature is measured as Delta T.

Sudden variation in Delta T may be caused by a faulty heater/cooler, blocked channel, scale build up etc.

Flosense, provides visibility of key cooling circuit metrics, improves efficiency, enhances productivity and profitability.

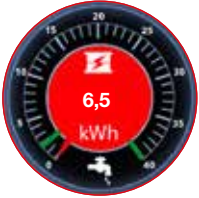

→ **ENERGY TRANSFER INDICATOR**

Heat is transferred from the mould through the water channels, Flosense calculates the heat transfer as energy units BTU or kWh. This feature illustrates the efficiency of the process.



→ **TURBULENT FLOW INDICATOR**

Often regarded as a key indicator in the efficiency of a mould cooling circuit, Flosense is fitted with a turbulent flow indicator. The unit will indicate laminar, transitional and turbulent flow as well as monitoring the Reynolds number, based on flow diameter and percentage glycol in the system.

Improving the flow from laminar to turbulent can increase the heat transfer efficiency by up to 500%.

Flosense, provides features and interfaces to monitor, analyse and verify data, essential for your productivity and quality.



→ **ALARM OUTPUT**

With programmable alarm limits on flow, temperature and pressure any variation in the values being monitored will trigger an on-screen alarm. An external alarm output signal can be connected to auxiliary equipment which could be a visual or audible beacon, the mould heater or the injection moulding machine.

Even in a 'hose burst' situation the unit will identify a sudden loss of pressure and the unit can either be connected to an alarm or could be used to automatically shut down the mould heater.



→ **DATA RECORDING**

Data is recorded and stored in the internal memory enough to display data for the previous 30 days.

Flow, Temperature and Pressure are logged and may be viewed in the graphing screen.



The last 30 days of data is recorded and stored on the internal memory.



→ **DATA EXPORT**

It is also possible to download the data to a laptop using the integrated USB port for further analysis.

The data is stored as text file and can be analysed using excel or other analysing software.

SINGLE FLOW SENSOR KIT

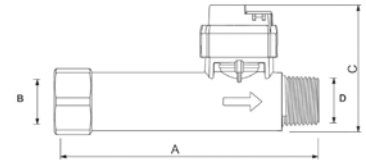
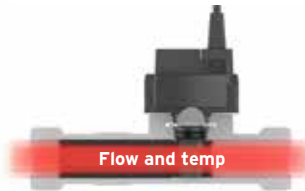

Part No.	Flow capacity l/m	A	Connection B	C	D	Max temperature
FSE-0612-K	0,6-12	100	G 1/2"	58,8	1/4"	120°C
FSE-0612-K-HT	0,6-12	100	G 1/2"	58,8	1/4"	160°C
FSE-120-K	1-20	100	G 1/2"	58,8	1/4"	120°C
FSE-120-K-HT	1-20	100	G 1/2"	58,8	1/4"	160°C
FSE-240-K	2-40	100	G 1/2"	58,8	1/4"	120°C
FSE-240-K-HT	2-40	100	G 1/2"	58,8	1/4"	160°C

Kit includes

- Touch Screen
- Power Supply
- Sensor (flow+temp)
- Cable (1,2 m.)
- USB Cable

SINGLE MULTI SENSOR KIT

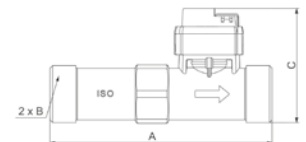
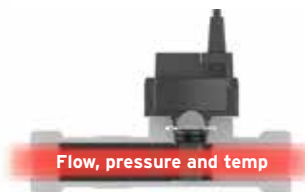

Part No.	Flow capacity l/m	A	Connection B	C	Max temperature	Pressure Range
FS-115-K	2-15	110	G 3/4"	58,8	120°C	0-10 Bar
FS-240-K	4-40	110	G 3/4"	58,8	120°C	0-10 Bar
FS-5100-K	10-100	129	G 1"	66,5	120°C	0-10 Bar
FS-10200-K	20-200	137,5	G 1-1/4"	74,1	120°C	0-10 Bar
FS-20400-K*	40-400	180	G 1-1/2"	85	120°C	0-10 Bar

Kit includes

- Touch Screen
- Power Supply
- Sensor (flow+temp)
- Cable (1,2 m.)
- USB Cable
- * Composite (PPS, PA66)

DUAL MULTI SENSOR KIT

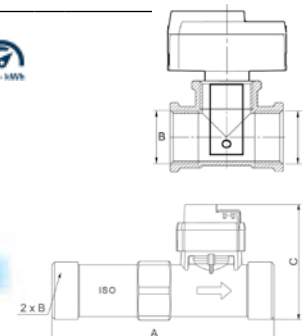
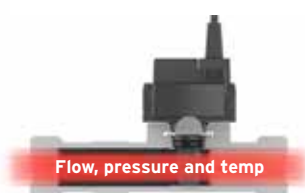

Part No.	Flow capacity l/m	A	Connection B	C	Max temperature	Pressure Range
FS-115-10-K	2-20	110	G 3/4"	58,8	120°C	0-10 Bar
FS-240-10-K	4-40	110	G 3/4"	58,8	120°C	0-10 Bar
FS-5100-10-K	10-100	129	G 1"	66,5	120°C	0-10 Bar
FS-10200-10-K	20-200	137,5	G 1-1/4"	74,1	120°C	0-10 Bar
FS-20400-10-K*	40-400	180	G 1-1/2"	85	120°C	0-10 Bar

Kit includes

- Touch Screen
- Power Supply
- Sensor (flow+temp+pressure)
- Inlet Sensor (Temp+pressure)
- 2 x Cables (1,2 m.)
- USB Cable
- * Composite (PPS, PA66)

TOUCH CONTROL

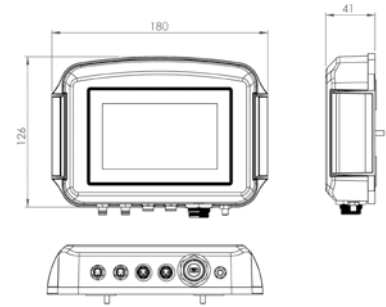

Part No.	Display Type	Sensor Input	Alarm Output	Voltage
FS-T400	Touch	2	Yes	12 V.

MULTI SENSOR UNIT

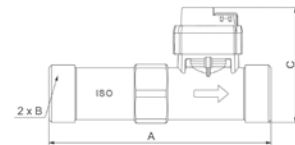

Part No.	Flow capacity l/m	Flow capacity			Max temperature	Hosetail Ref.
		A	B	C		
FS-115	2-15	110	G 3/4"	58,8	120°C	CFR3/4-13
FS-240	4-40	110	G 3/4"	58,8	120°C	HT-316-2 / CFR3/4-19
FS-5100	10-100	129	G 1"	66,5	120°C	CFR1-25 / CFR1-25
FS-10200	20-200	137,5	G 1-1/4"	74,1	120°C	HT-316-4 / CFR1.1/4-32
FS-20400	40-400	180	G1-1/2"	80,1	120°C	1.1/2" / 38 mm. (Included)

Description

Includes Flow Pipe and Multi Sensor (cable not included)

FLOW SENSOR UNIT

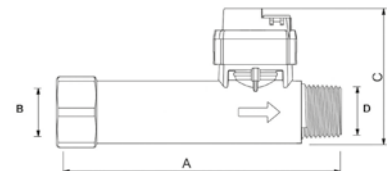

Part No.	Flow capacity l/m	Flow capacity				Max temperature	B Connection ref.
		A	B	C	D		
FSE-0612	0,6-12	100	G 1/2"	58,8	1/4"	120 °C	xxNRF
FSE-0612-HT	0,6-12	100	G 1/2"	58,8	1/4"	160 °C	xxNRF
FSE-120	1-20	100	G 1/2"	58,8	1/4"	120 °C	xxNRF
FSE-120-HT	1-20	100	G 1/2"	58,8	1/4"	160 °C	xxNRF
FSE-240	2-40	100	G 1/2"	58,8	1/4"	120 °C	xxNRF
FSE-240-HT	2-40	100	G 1/2"	58,8	1/4"	160 °C	xxNRF

Description

Includes Flow Pipe and Multi Sensor (cable not included)

OPTIONAL (NOT INCLUDED IN THE KIT) AISI 316 SWIVEL HOSETAIL FITTINGS



GASKETS

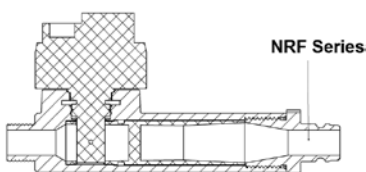

Stainless Steel Part No.	Brass Part No.	A1 x D1	Sensor Ref.	Part No.
	CFR3/4-13	3/4" X 13	FS-115	GK34
HT-316-2	CFR3/4-19	3/4" X 19	FS-240	GK34
HT-316-3	CFR1-25	1" x 25	FS-5100	GK1
	CFR1.1/4-32	1.1/4 x 32	FS-10200	GK114
	CFR1.1/2-38	1.1/2 x 38	FS-20400	GK112

PORT CONNECTOR PLUGS

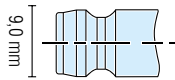
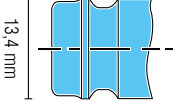
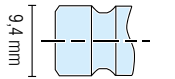
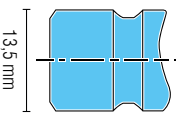
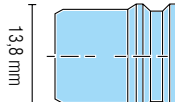
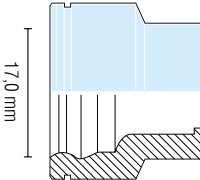

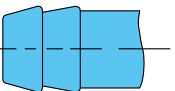
Part No.	Connection	Size/series		
09NRF	R 1/2"	09 EURO Style		
13NRF	R 1/2"	13 EURO Style		
20NRF	R 1/2"	20 Int. Style		
30NRF	R 1/2"	30 Int. Style		
08NRF	R 1/2"	French Type		
F9NRF	R 1/2"	French Type		
06NRF	R 1/2"	06 Scandinavian Style		
10MF	R 1/2"	10 mm Hosetail		
13MF	R 1/2"	13 mm Hosetail		

Distributor

MOULDPRO ApS
Baltorpbakken 10
DK-2750 Ballerup, Denmark
www.mouldpro.com
Phone: +45 7020 3131

flosense[®]
BY MOULDPRO